

THE SOVEREIGN INFRASTRUCTURE BLUEPRINT

ARCHITECTURE FOR THE POST-CENTRALIZED ECONOMY

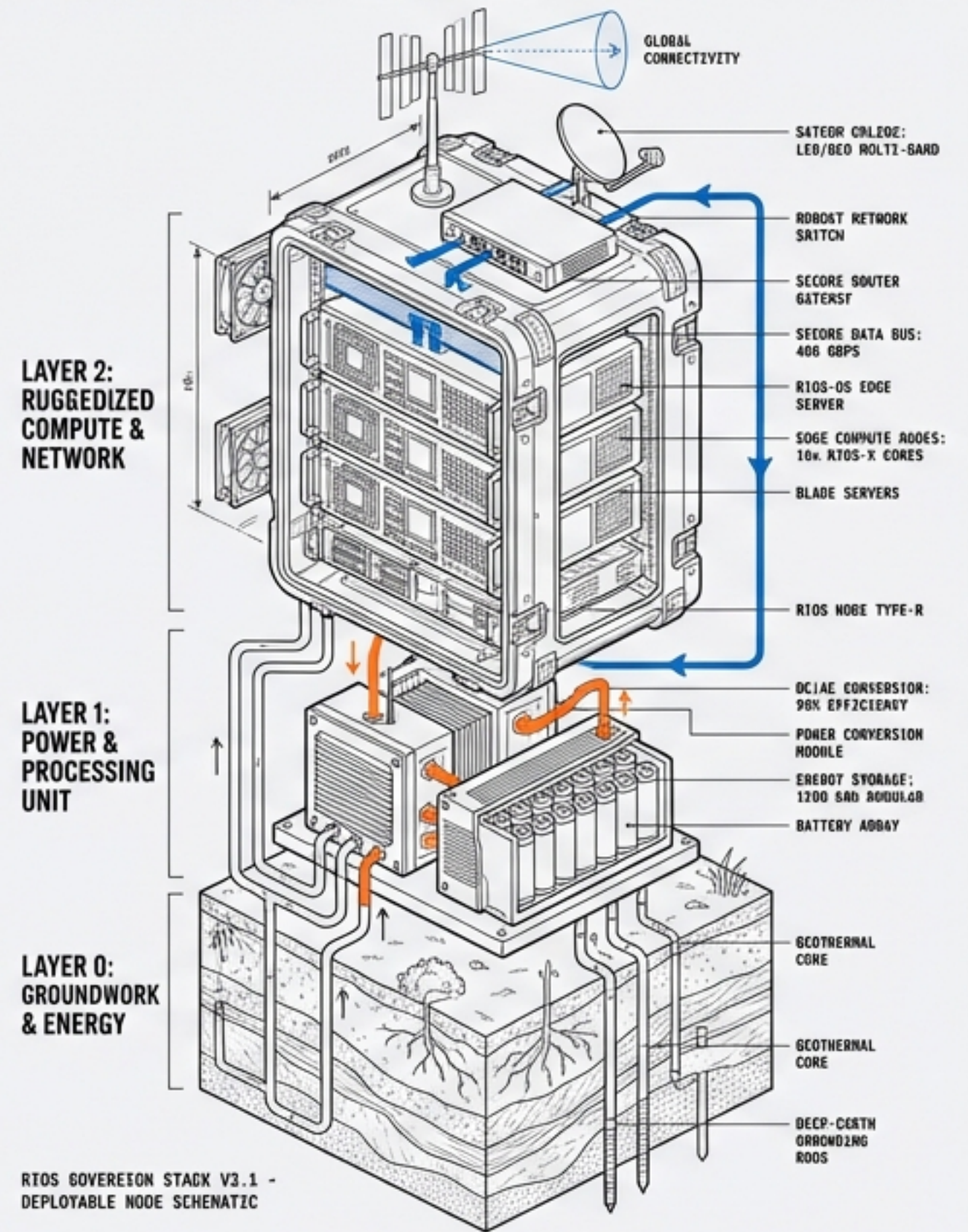

EXECUTIVE SUMMARY: THE MENTORSHIP LAYER

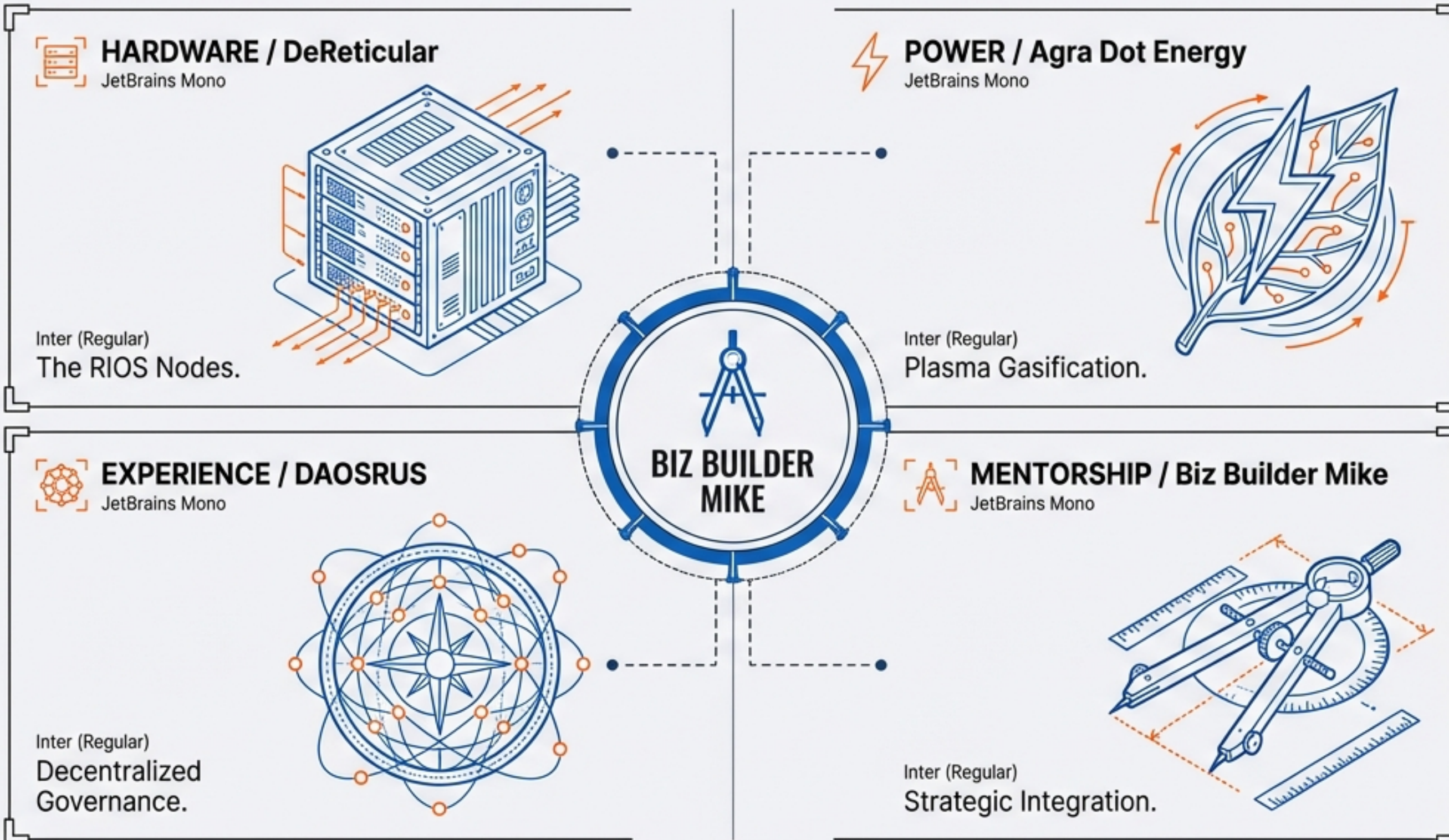

JetBrains Mono

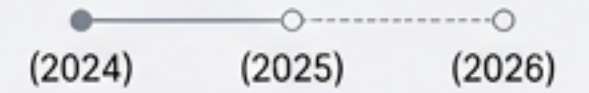

From Theory (2024) to Architecture (2025) to Activation (2026).

Inter (Regular)

Biz Builder Mike functions as the "Local Economic Architect," bridging the gap between high-tech hardware and local revenue generation.



The Velcro Principle:
Value is created by tightly integrating disparate sectors—waste heat fuels agriculture; agricultural waste fuels power.

THE PROBLEM: MANDATE FOR ABSOLUTE RESILIENCE

“You can’t sail today’s boat on yesterday’s wind.”

OLD WORLD: 1,000-MILE FAILURE MODEL

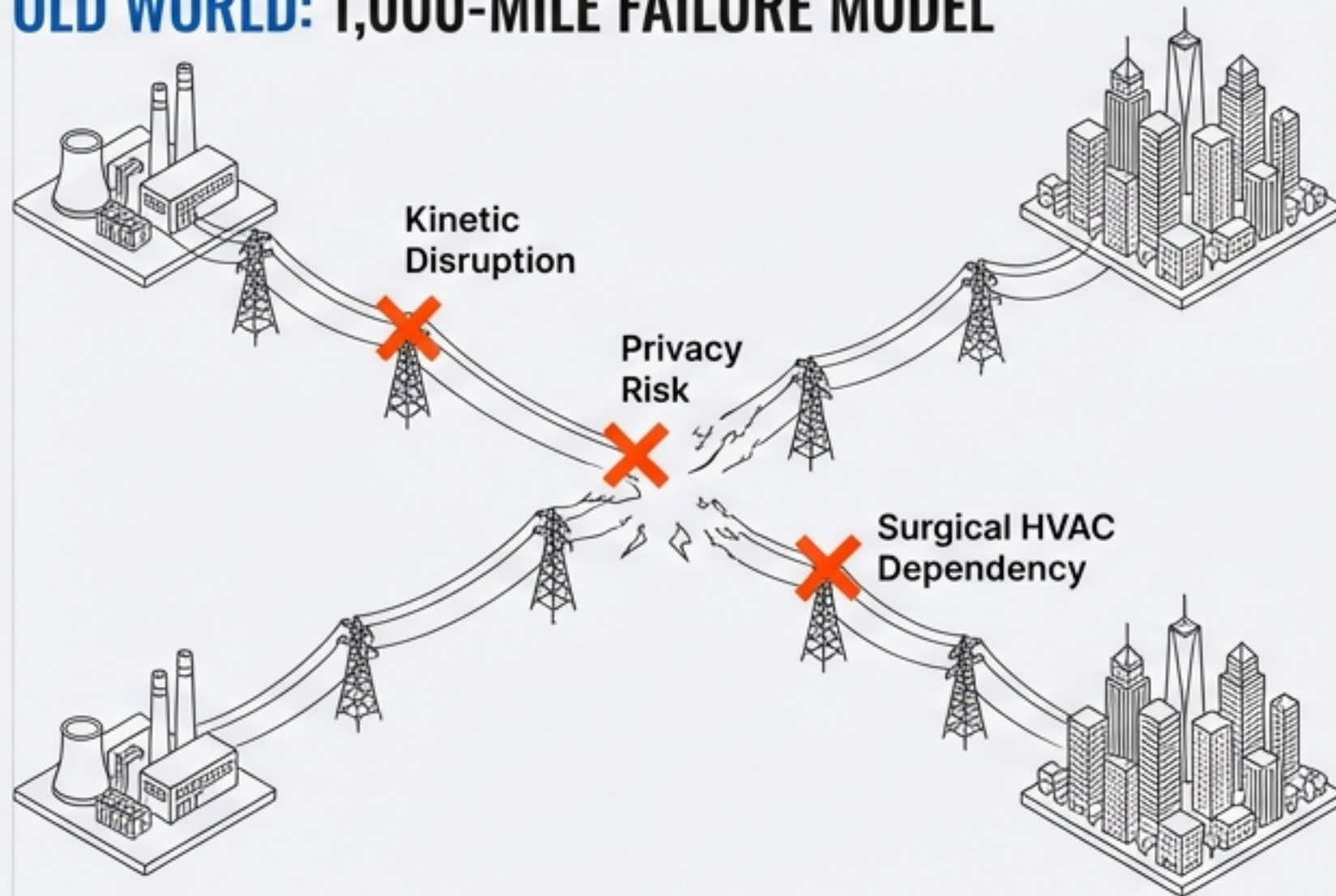

SOVEREIGN AGE: SPHERICAL MESH RESILIENCE

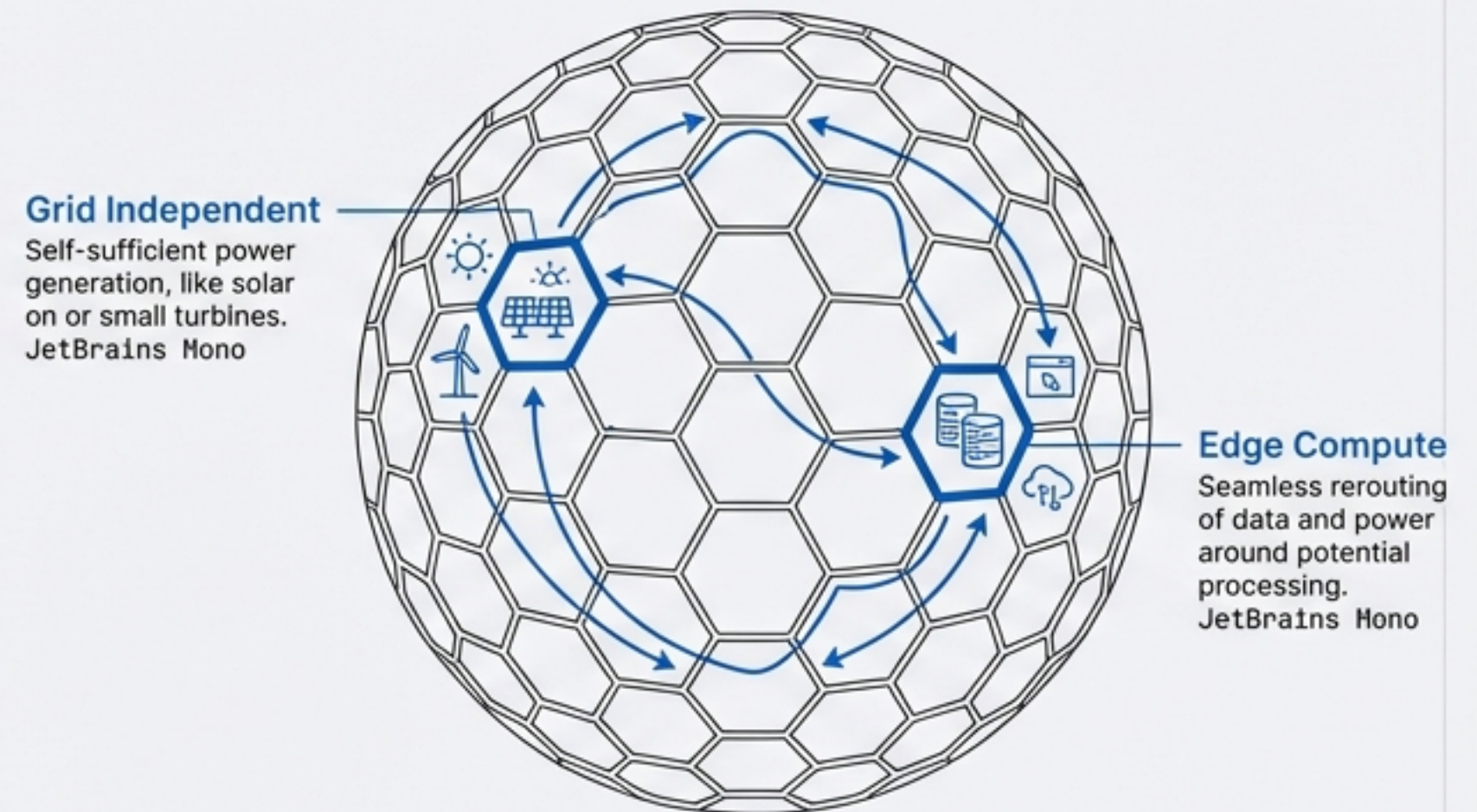

Current infrastructure is structurally destined to fail.
We are shifting from linear fragility to spherical resilience.

DEFINING THE SOVEREIGN STACK

Data is the New Oil. Privacy is the New Gold.

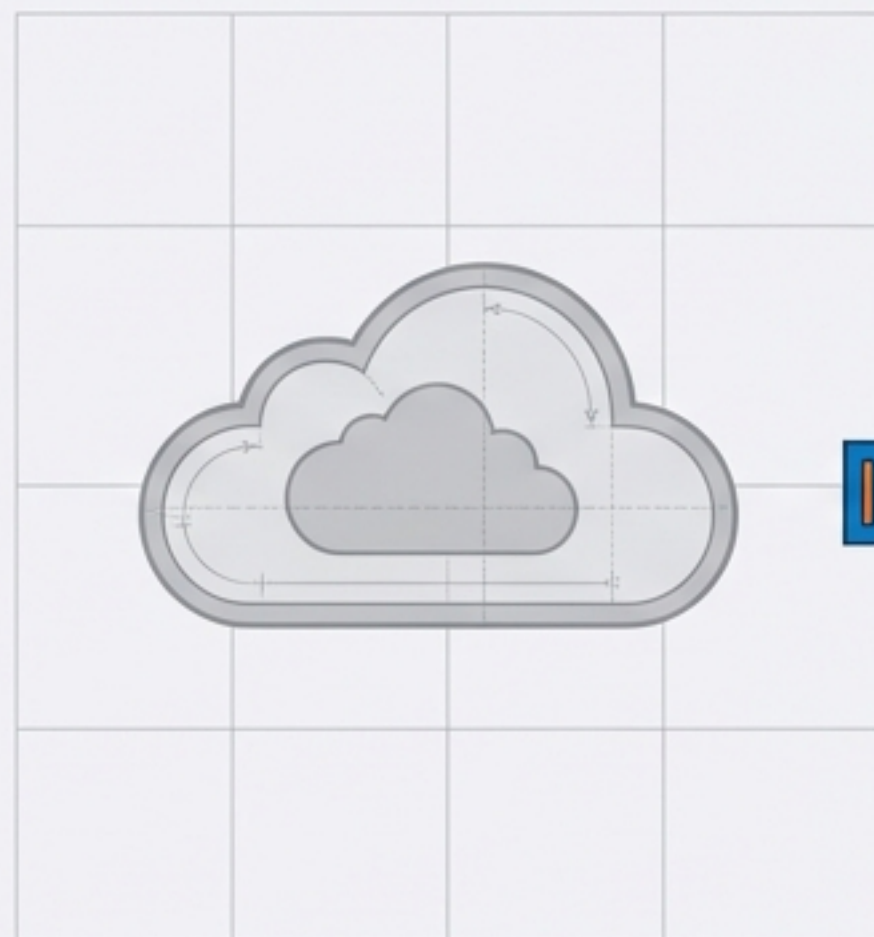

CENTRALIZED CLOUD

- Rented Access
- Surveillance
- Latency

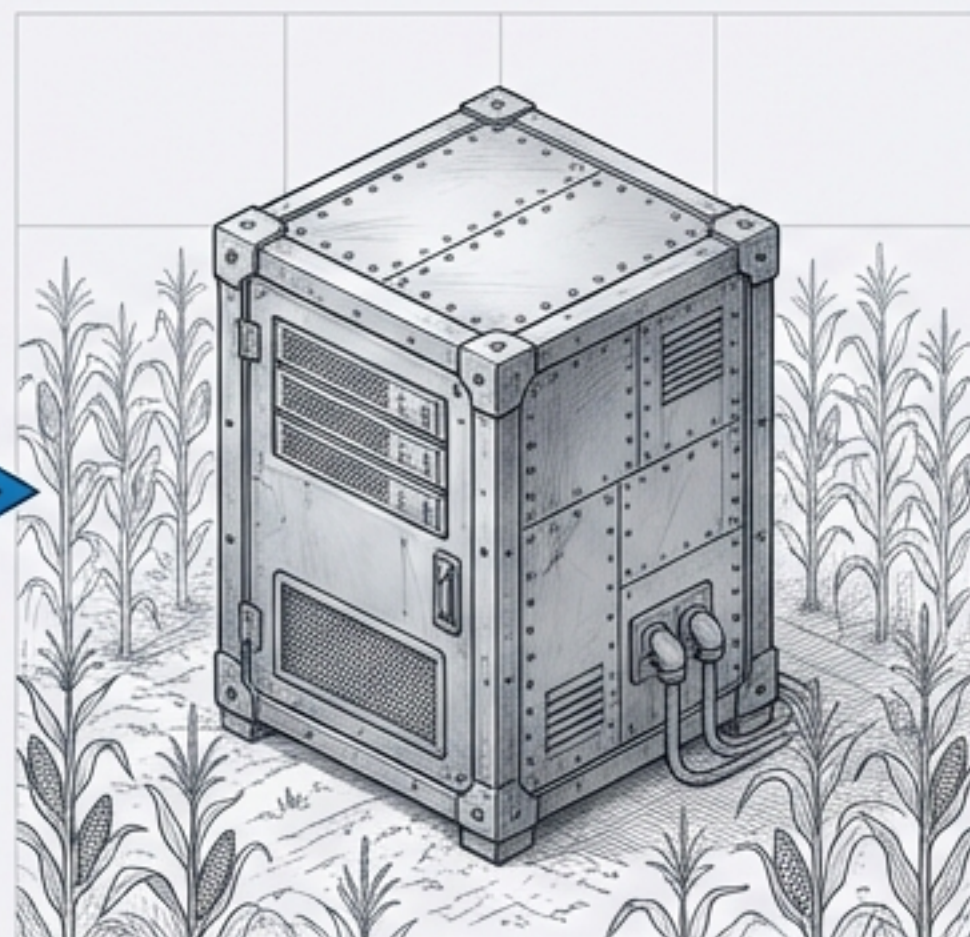

THE DATA VAULT (RIOS)

- Sovereign Ownership
- Edge Computing
- Privacy Preserved

RIOS DEFINITION:

The **Rural Infrastructure Operating System** is not IT equipment. It is a field-deployable asset classification for **Kinetic Environments**.

THE ENGINE: CARBON-CONSUMING CIRCULAR ECONOMIES

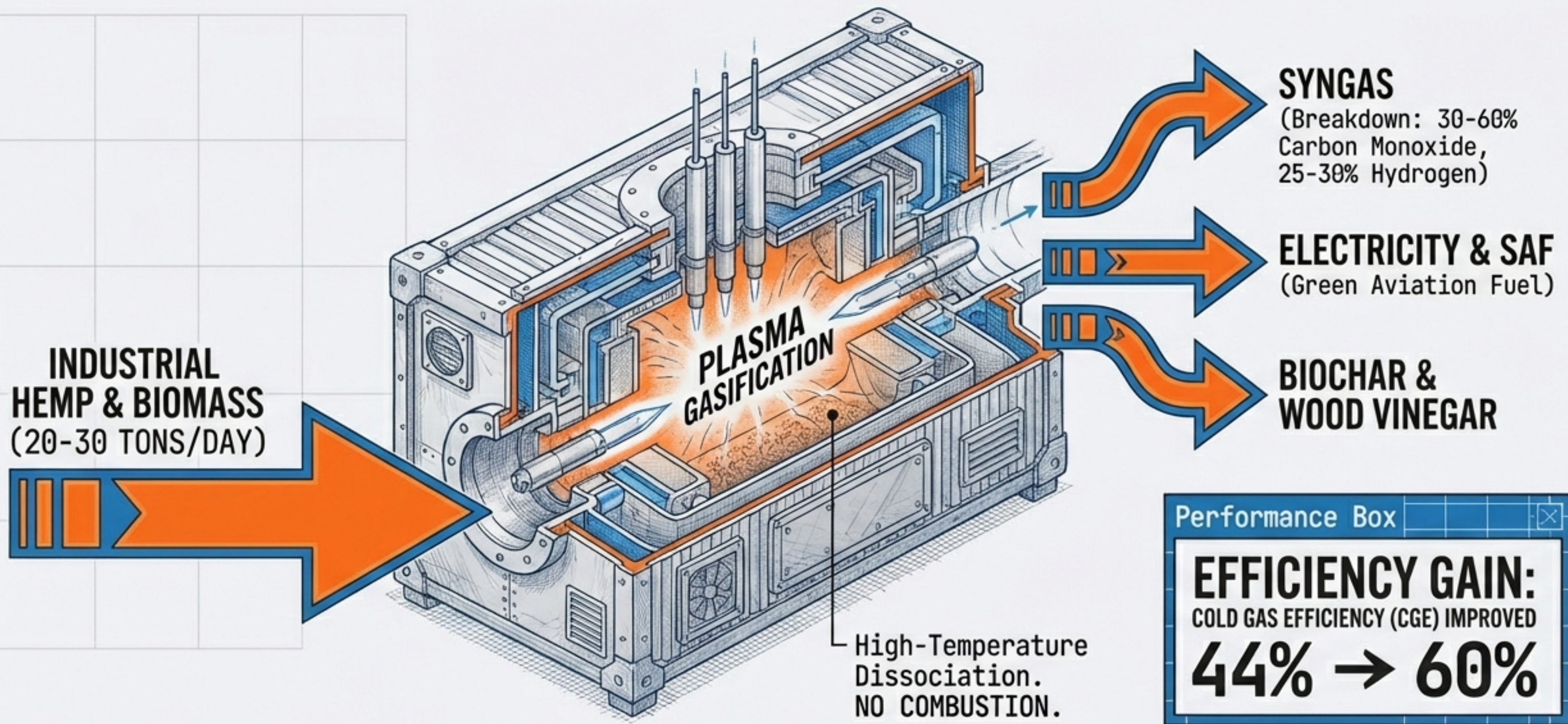

THE AGRICULTURAL FLYWHEEL

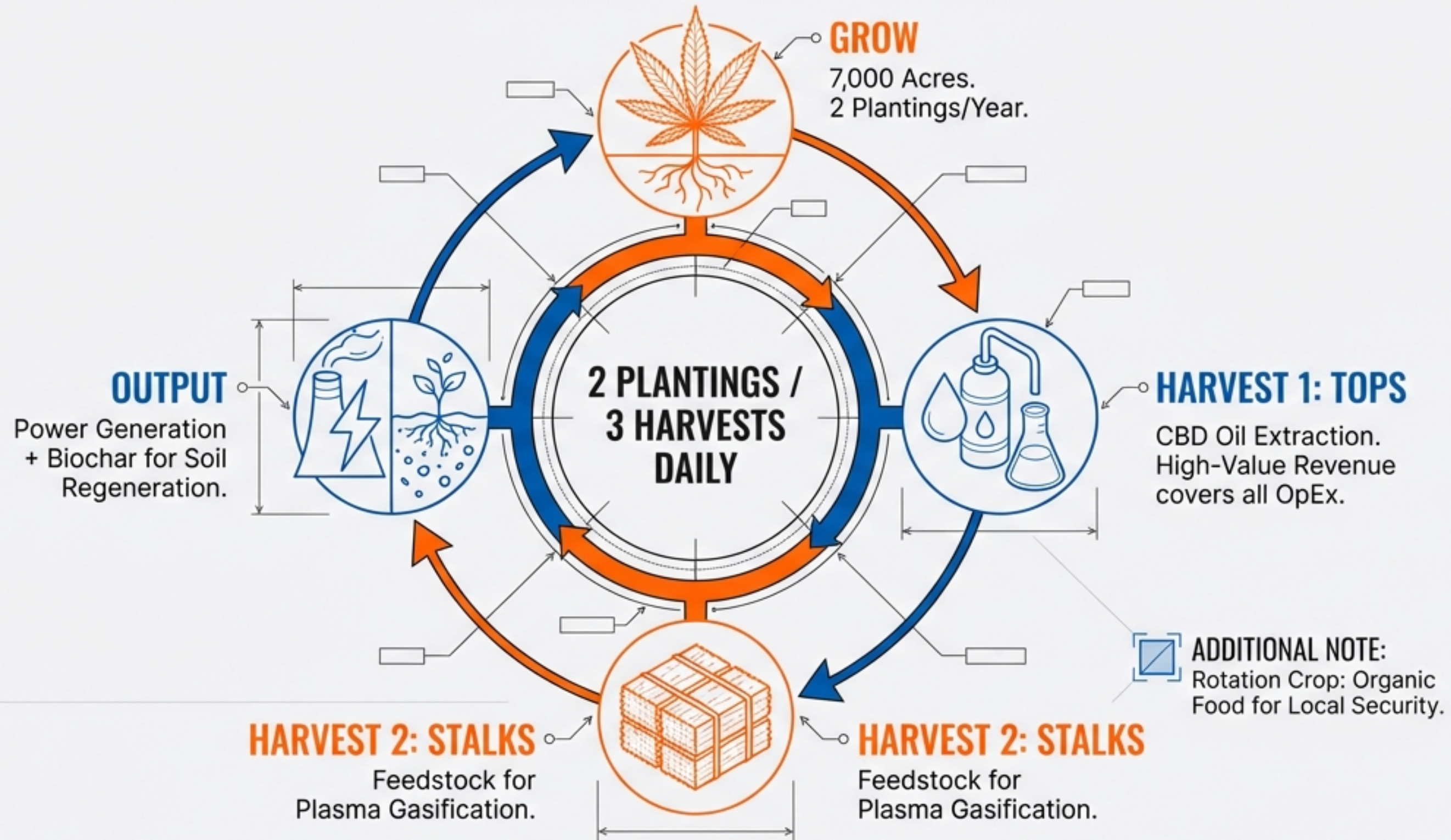

CONNECTIVITY LAYER: **WAAMNET**

Project Unplugged: Independent of the Backbone.

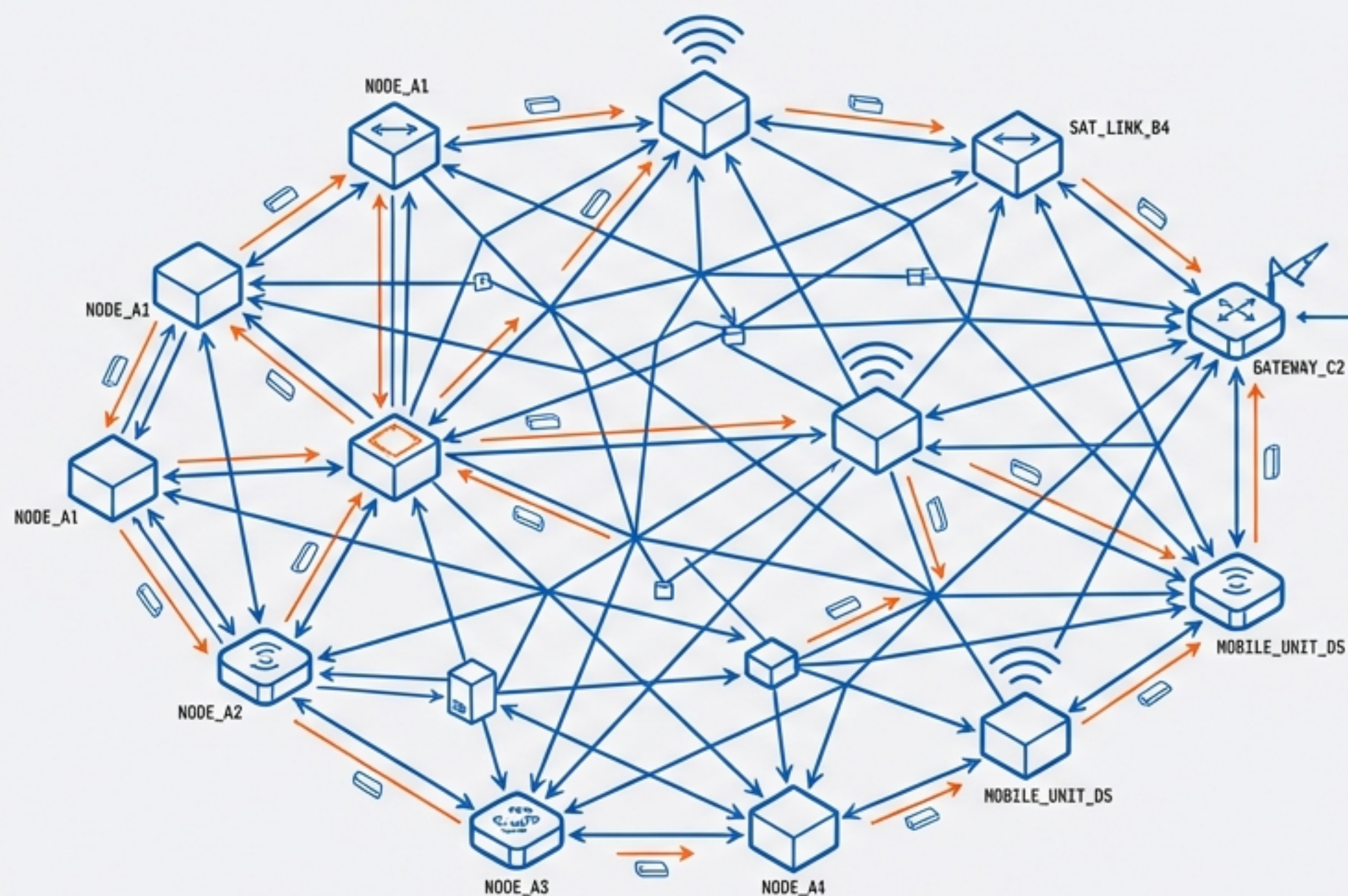

NETWORK: Wireless Autonomous Massive Network (**WAAMNET**).
LTE-4/LTE-5 **Private Mesh**.

PROTOCOL: Named Data Networking (**NDN**).
Replaces TCP/IP for **inherent security**.

STORAGE: **IPFS** (InterPlanetary File System). **Decentralized**.

HARDWARE: **Intelligent eSIMs** +
Starlink Bonding.



TRADITIONAL
ISP



**AUTONOMOUS
OPERATION**

TRUST LAYER: THE END OF THE AUDIT

Replacing expensive, fallible centralized auditors (SGS/Bureau Veritas) with immutable Blockchain verification.

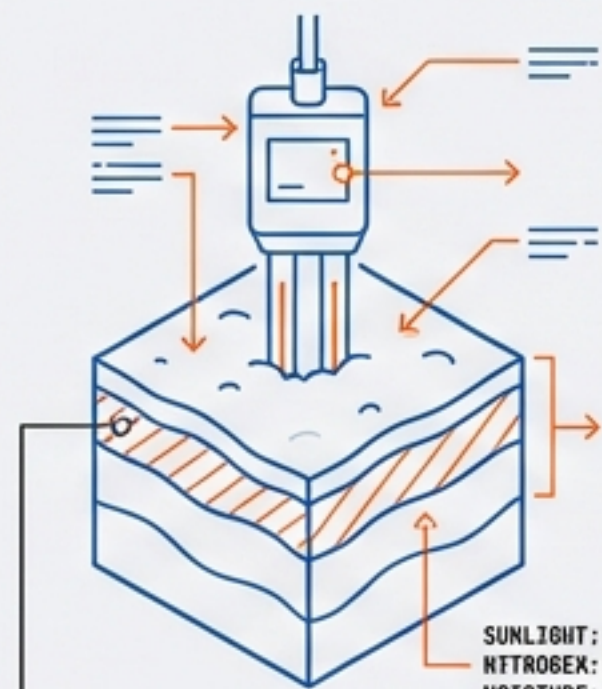

IOT SENSORS
Real-time tracking of sunlight, nitrogen, moisture.

JetBrains Hono



DIGITAL TWIN
Production data creates an NFT.

UNEQUE DIGITAL ASSET (UDA) ID: #7263-A485



AUTOMATED TRUST
Buyers verify carbon-negative status instantly.

INSTANT VERIFICATION: SMART CONTRACT EXECUTED



TOKENIZATION
Real World Assets (RWA) sold on-chain.

LIQUIDITY POOL: GLOBAL ACCESS

ECONOMIC MODEL: THE DATA FLYWHEEL

TARGET: 100 CAMPUSES

Inter Regular

(MAY 2027)

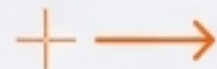

JOBS: 250 PER CAMPUS

Inter Regular



IMPACT: REPATRIATION OF WEALTH

Inter Regular

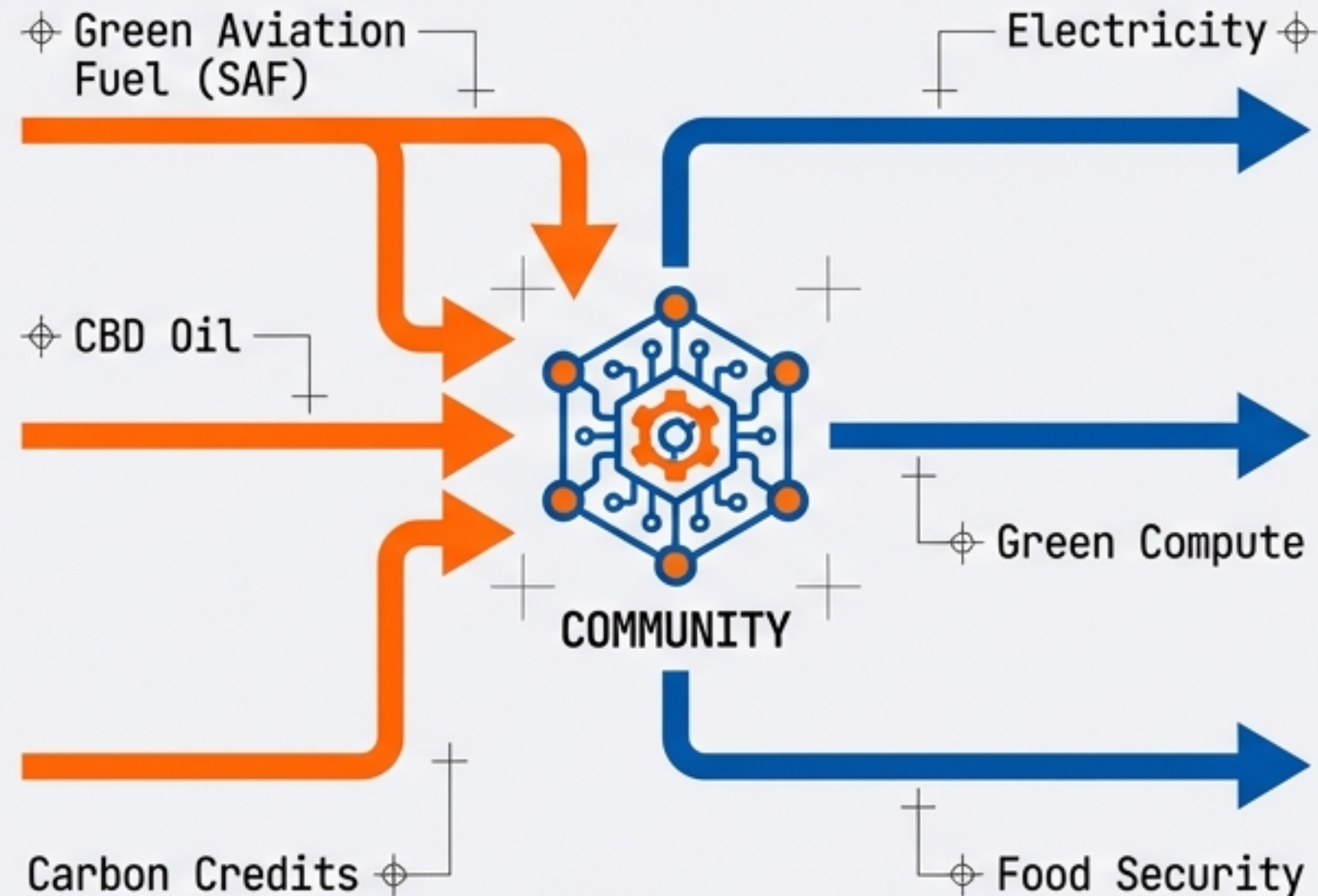

Employees paid in **Utility Tokens**, circulating wealth within the local economy.

2025: THE YEAR OF THE BLUEPRINT



THE MACHINE IS BUILT.

2026 STRATEGY: THE OCTAGON & TOKENIZATION

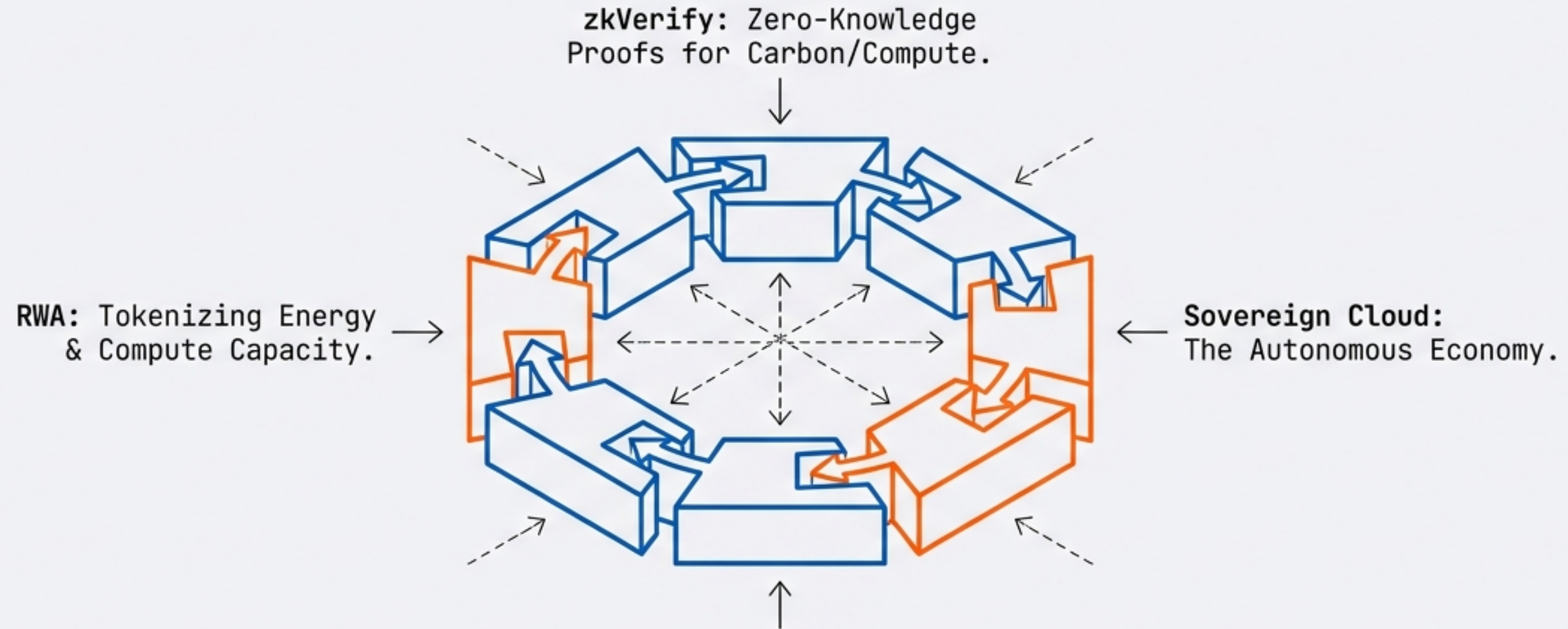

2026 is the Year of Tokenization. We are integrating the financial layer directly into the hardware.

CALL TO BUILDERS: HACK THE FORGE

WE BUILT THE FOUNDATION. YOU BUILD THE APPLICATION LAYER.



1. GET PREPPED: Download the GTM Toolkit.



2. APPLY: CodeLaunch GTM Venture Forge.



3. DOMINATE: Use the Sovereign Infrastructure narrative.

**WINNERS GET A FREE PROFESSIONAL
DEV TEAM TO BUILD THEIR MVP.**

A faint, light blue wireframe architectural drawing of a building or structure is centered in the background, behind the main text.

GO. BUILD. WIN.

WELCOME TO THE SOVEREIGN AGE.